



PRODOTTI VARI
OTHER PRODUCTS
AUTRES PRODUITS



Cavalletto doppio a gambe girevoli

Adjustable double trestle with revolving feet

Tréteau de maçon avec pieds pivotants

Code	H min /m	H max /m	Weight /Kg
CAV-DOP	1,00	1,80	11,80

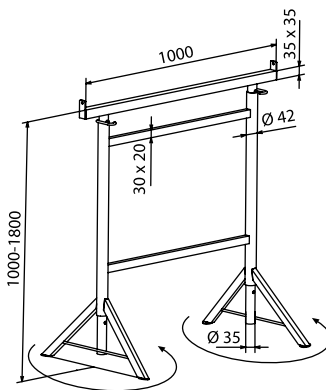

- Gancio ø 8 mm
Portata ammissibile 150 Kg
Pacchi da 30 pezzi

- Pin ø 8 mm
Admitted load 150 Kg
Packages of 30 pieces

- Broche ø 8 mm
Charge admissible 150 Kg
Colis de 30 pièces

Cavalletto doppio a gambe fisse

Adjustable double trestle with fixed feet

Tréteau de maçon avec pieds fixes

Code	H min /m	H max /m	Weight /Kg
CAV-DOP2	1,00	1,80	10,70

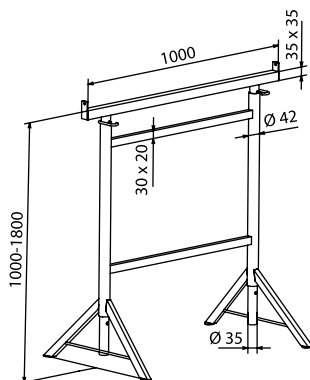

- Gancio ø 8 mm
Portata ammissibile 150 Kg
Pacchi da 15 pezzi

- Pin ø 8 mm
Admitted load 150 Kg
Packages of 15 pieces

- Broche ø 8 mm
Charge admissible 150 Kg
Colis de 15 pièces

Cavalletto tripla estendibile

Adjustable trestle for ceiling

Tréteau à position variable

Code	H min /m	H max /m	Weight /Kg
CAV-TRI	0,80	1,40	20,00

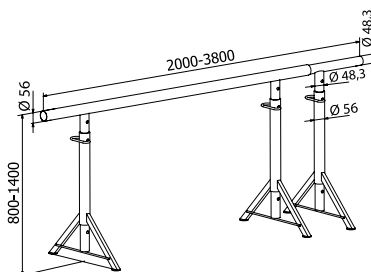

- Larghezza min 2,00 m
Larghezza max 3,80 m
Gancio ø 12 mm
Pacchi da 10 pezzi

- Width min. 2,00 m
Width max 3,80 m
Pin ø 12 mm
Packages of 10 pieces

- Longueur min 2,00 m
Longueur max 3,80 m
Broche ø 12 mm
Colis de 10 pièces

Parapetto a vite zincato classe A

Screw parapet class A

Pince-dalle à vis classe A

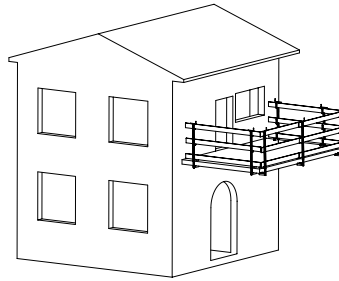

Conforme alla norma EN 13374_2013
In compliance with EN 13374_2013
Conforme à la norme EN 13374_2013

Code	H /m	pcs /Pack	Weight /Kg
PAR_VIT1_ZE	1,00	150	6,30
PAR_VIT1L_ZE	1,20	Libera - Free - Libre	6,40

Apertura massima 80 cm - Maximum opening 80 cm - Ouverture maximale 80 cm.

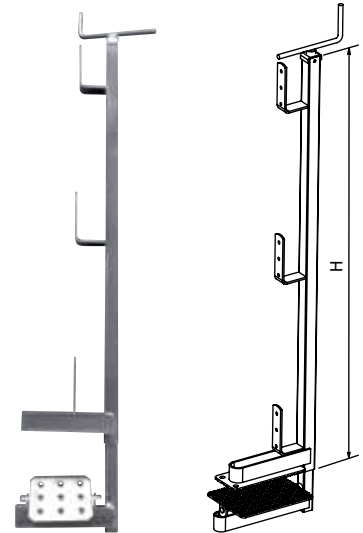

Porta secchio doppio

Support for 2 buckets

Support pour 2 seaux

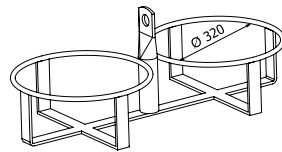

Code	Pack	Weight /Kg
PS_01	Libera - Free - Libre	6,00

Porta secchio quadruplo

Support for 4 buckets

Support pour 4 seaux

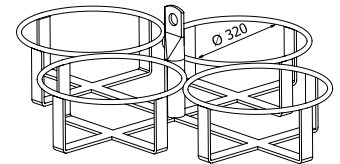

Code	Pack	Weight /Kg
PS_02	Libera - Free - Libre	10,00

Benna trapezoidale

Trapezoidal bucket

Benne trapézoïdale

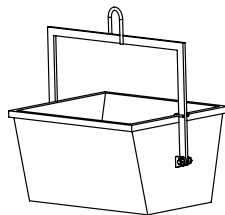

Code	Capacity /lt	Pack	Weight /Kg
BENNA-T_045	45	Libera - Free - Libre	14,00
BENNA-T_080	80	Libera - Free - Libre	18,00
BENNA-T_120	120	Libera - Free - Libre	25,00

Rigone per parete con o senza pedale

Ruler with spring for walls with or without pedal

Règle pour les murs avec ou sans pédale

Code		Mod.	pcs /Pack	Weight /Kg
R320_ZE	●	320	30	4,50
RP320_ZE	◆	320	30	4,50
R400_ZE	●	400	30	5,50
RP400_ZE	◆	400	30	5,50
RMAN	■	-	Libera - Free - Libre	0,50

● Senza pedale, zincato
Without pedal, galvanized
Sans pédale, galvanisée

◆ Con pedale, zincato
With pedal, galvanized
Avec pédale, galvanisée

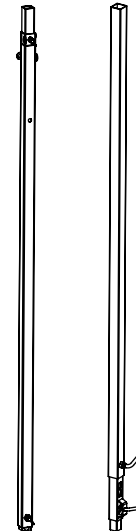

Code: RMAN ■
Maniglia per rigone
Handle for ruler
Poignée pour règle

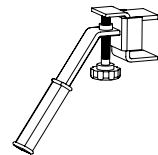

Mensola per carrucola

Shelf for pulley

Potence pour poulie

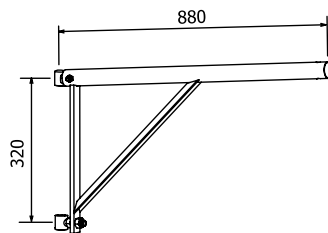

Code	Pack	Weight /Kg
MENS_CAR	Libera - Free - Libre	9,00

Mensola pivotante per argano

Swivel bracket for hoist

Potence pivotante pour treuil

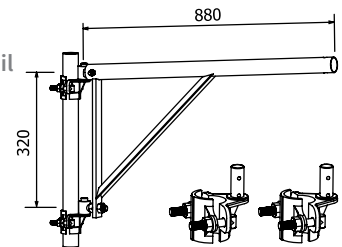

Code	Pack	Weight /Kg
MENS_ARG	Libera - Free - Libre	12,40

Copertura copri betoniera zincata

Galvanized roofing for mixer

Couverture galvanisée pour bétonnière

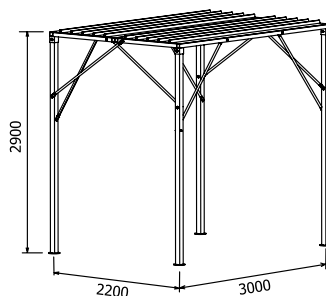

Code	Pack	Weight /Kg
COP_01	Libera - Free - Libre	190,00

Scivolo scarica detriti
Conveyor for dumping rubble
Déchargeoirs à décombres

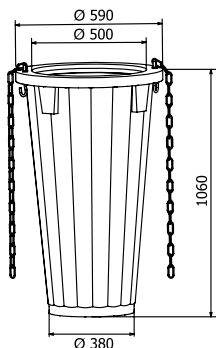

Code: PLAS_04

Scivolo
Conveyor
Déchargeoirs



Code: PLAS_08

Catena di ricambio
Spare chain
Chaîne de rechange

Code	Pack	Weight /Kg
PLAS_04	Libera - Free - Libre	9,00
PLAS_08	Libera - Free - Libre	0,50

Tramoggia di carico
Hopper
Trémie

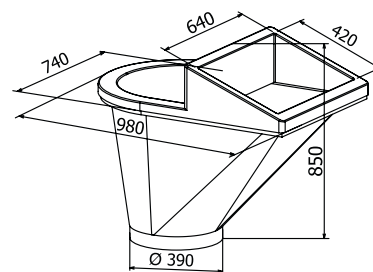

Code	Pack	Weight /Kg
PLAS_05	Libera - Free - Libre	8,50

Telaio per tramoggia
Frame for hopper
Cadre pour trémie

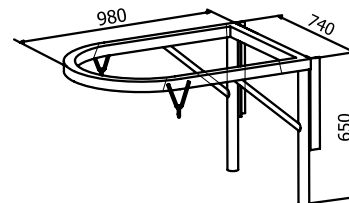

Code	Pack	Weight /Kg
PLAS_06	Libera - Free - Libre	16,00

Barriera stradale in plastica
Plastic road separator
Séparateur de route en plastique

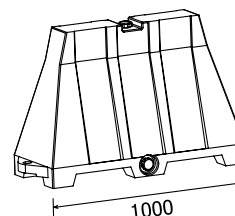

Code	pcs /Pallet	Weight /Kg
PLAS_07	36	7,00

Tappo di protezione per tondo d'armatura

Protection cap for reinforcing bars

Bouchon en plastique de sécurité

Code	Ø /mm	pcs /Pack	Weight /Kg
PLAS_13	6 - 20	400	0,02
PLAS_18	16 - 32	300	0,03

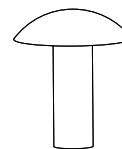

Distanziatore PVC universale rapid

Universal PVC spacer

Entretoises universelles en PVC

Code	L /cm	H /cm	pcs /Pack
PLAS_DISTL-H015	200	1,50	50
PLAS_DISTL-H020	200	2,00	50
PLAS_DISTL-H025	200	2,50	50
PLAS_DISTL-H030	200	3,00	50
PLAS_DISTL-H035	200	3,50	32
PLAS_DISTL-H040	200	4,00	32
PLAS_DISTL-H050	200	5,00	32

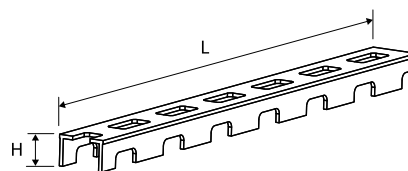

Rete zincata per massetto 100x200 cm

Galvanized electrowelded net for screed 100x200 cm

Réseau électro soudé galvanisée pour chape 100x200 cm

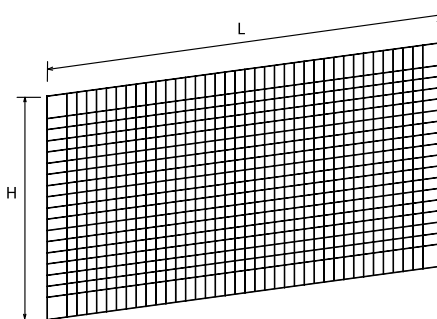
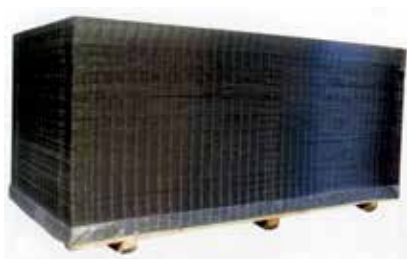

Code	L /cm	H /cm	Maglia /mm Mesh /mm Maille /mm	Filo /Ø mm Wire /Ø mm Fil /Ø mm	Pannelli /bancale Panels /pallet Panneaux /palette	Weight /Kg (cad)
RETE_MAS01	200	100	60x60	1.4	800	0,76

Chiodi testa piana standard

Nails for construction

Clous standard pour la construction



Code	Ø /mm (JpD)	L /mm
CHIO13X030	2,00 (13)	30
CHIO15X050	2,40 (15)	50
CHIO16X060	2,70 (16)	60
CHIO17X070	3,00 (17)	0
CHIO18X080	3,50 (18)	80
CHIO20X100	4,50 (20)	100
CHIO21X120	5,00 (21)	120

- Costruiti secondo norma EN 10230.
Gamma completa di chiodi a testa piana.
Scatole da 5 kg.
Etichetta su ogni scatola con peso e misura.
Bancali da 1.000 kg / 1080 kg.
Protezione bancale con pellicola in polietilene.
* Altre lunghezze disponibili su richiesta.

- Produced according to EN 10230.
Complete range of nails for construction.
Boxes of 5 kg.
Each box is labeled with dimensions and weight.
Pallets of 1.000 kg / 1080 kg.
Pallet protected by a polyethylene film.
* Other lengths available upon request.

- Produit selon la norme EN 10230.
Gamme complète de clous pour la construction.
Boîtes de 5 kg.
Label sur chaque boîte avec poids et mesure.
Palette de 1000 kg / 1080 kg.
Palette protégée avec pellicule en polyéthylène.
* Autres longueurs disponibles sur demande.

Chiodi testa bombata in acciaio brunito o zincato

Steel black and galvanized nails for construction

Clous en acier brunis et galvanisée pour la construction



Code		Ø /mm (JpD)	L /mm
●	◆		
CHIO_ACC40	CHIO_ACCZ40	3,00 (17)	40
CHIO_ACC50	CHIO_ACCZ50	3,50 (18)	50
CHIO_ACC60	CHIO_ACCZ60	3,50 (18)	60
CHIO_ACC70	CHIO_ACCZ70	3,50 (18)	70

● Acciaio brunito
Black steel
Acier Brunis

◆ Acciaio zincato
Galvanized steel
Aciee galvanisée

- Scatole da 2,5 kg.
Etichetta su ogni scatola con peso e misura.
Bancali da 1.000/1.200 Kg.
Protezione bancale con pellicola in polietilene.
Bruniti o zincati.
* Altre lunghezze disponibili su richiesta.

- Boxes of 2,5 kg.
Each box is labeled with the dimensions and weight.
Pallet of 1.000/1.200 kg.
Pallet protected by a polyethylene film.
Blued or galvanized.
* Other lengths available upon request.

- Boîtes de 2,5 kg.
Étiquette sur chaque boîte indiquant poids et mesure.
Palette de 1000/1200 kg.
Palette protégée avec pellicule en polyéthylène.
Brunis ou galvanisés.
* Other lengths available upon request.

Filo cotto nero

Black annealed wire

Fil recuit noir

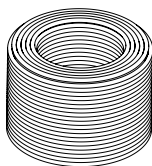

Code	Ø /mm (JpD)
FIL05	1,00 (05)
FIL08	1,30 (08)
FIL10	1,50 (10)
FIL12	1,80 (12)
FIL14	2,20 (14)
FIL15	2,40 (15)
FIL16	2,70 (16)
FIL17	3,00 (17)
FIL18	3,50 (18)
FIL19	4,00 (19)
FIL21	5,00 (21)

- Filo cotto nero secondo la norma DIN 177.
Tensione massima di trazione di 450 N/mm².
Matasse da 25 kg. Imballo da 500 Kg.
Coils da 500/800 kg, reggiati in 4 punti e protetti da una pellicola di polietilene.

- Black annealed wire according to DIN 177.
Ultimate tensile strength of 450 N/mm².
Coils of 25 kg. Packaging of 500 Kg.
Coils packaged with polyethylene sheets and bound in a 500 Kg bale, with cold rolled steel strip.

- Fil recuit noir qui respecte la DIN 177.
Résistance à traction de 480 N/mm².
Couronnes de 25 kg. Emballage de 500 Kg.
Bottes de 500 kg et plus avec ligatures en feuillard.

Filo cotto bianco in bobine

White annealed wire in hanks

Fil recuit blanc en bobine



Code	Ø /mm (JpD)	Wires
BOB_B-4x2	0,90 (4)	2
BOB_B-4x3	0,90 (4)	3
BOB_B-5x2	1,00 (5)	2
BOB_B-5x3	1,00 (5)	3

- Filo cotto bianco in bobine.
Bobina da 0,330 kg.
Scatole da 25 kg.
Bancale da 1125 kg.
Bobine protette da una pellicola di polietilene.

- White annealed wire in hanks.
Hanks of 0,330 Kg.
Packed in boxes of 25 kg.
Pallets of 1125 kg.
Hanks protected with a polyethylene film.

- Fil recuit blanc en bobine.
Bobine de 0,330 kg.
Boîtes de 25 kg.
Palette de 1125 kg.
Bobine protégée avec film de polyéthylène.

Pannello recinzione mobile zincato - 200x350 cm

Galvanized mobile fence panel - 200x350 cm

Panneau galvanisée de clôture mobile - 200x350 cm

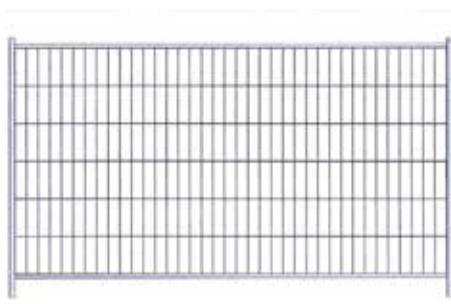

Code	L /cm	H /cm	Vertical Tubes Ø /mm	Horizontal Tubes Ø /mm	Weight /Kg (cad)
RECMOB_P200X350	350	200	40	32	14,00
RECMOB_P200X350P	350	200	40	40	16,00

Cerniera per cancello recinzione mobile

Hinge for mobile fence gate

Charnière pour porte de clôture mobile

Code	Weight /Kg (cad)
RECMOB_CERN	0,60



Morsetto blocca tubi zincati

Clamp for galvanized pipes

Pince pour tuyaux galvanisés

Code	pcs /Pack	Weight /Kg (cad)
RECMOB_GIUN	25	0,50

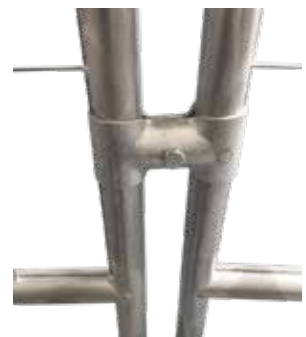

Cancello per recinzione mobile zincato

Galvanized mobile fence gate

Porte galvanisée de clôture mobile

Code	L/cm	H/cm	Weight /Kg (cad)
RECMOB_P200X100	100	200	8,00
RECMOB_P200X200	200	200	10,00



Pannello recinzione mobile zincato 200x350 cm con cancello

Galvanized mobile fence panel 200x350 cm with gate

Panneau de clôture mobile galvanisé 200x350 cm avec porte

Code	L/cm	H/cm	Weight /Kg (cad)
RECMOB_C200X350	350	200	23,00

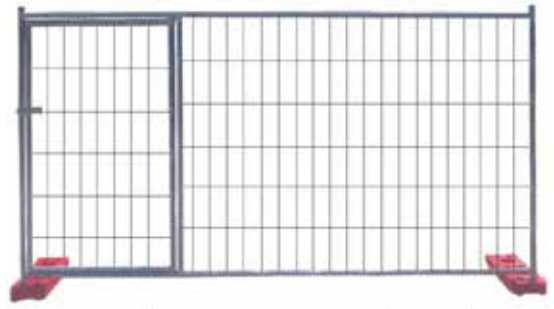

Pannello recinzione mobile zincato 100x350 cm

Galvanized mobile fence panel 100x350 cm

Panneau de clôture mobile galvanisé 100x350 cm

Code	L/cm	H/cm	Weight /Kg (cad)
RECMOB_P100X350	350	100	12,00

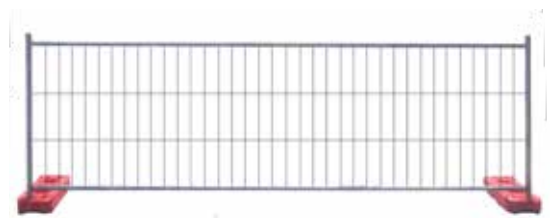

Basamento per recinzione mobile

Plinth for mobile fence

Plot pour clôture mobile

Code	Pcs/Pallet	Weight /Kg (cad)
RECMOB_BCLS	40	28,00
RECMOB_BPVC	40	28,00



Contenitore per 30 pezzi di recinzioni mobili
 Metal container for 30 pieces of mobile fences
 Panier de stockage pour 30 pièces de clôture mobile



Code	Pcs/Pallet
RECMOB_CONT	Libera - Free - Libre

Transenna mobile zincata
 Galvanized mobile transenna
 Transenna mobile galvanisé



Code	L/cm	H/cm	Weight /Kg (cad)
RECMOB_TR200X110	200	110	21,00
RECMOB_TR250X110	250	110	25,00

Banda di segnalazione cantiere In lamiera zincata
 Construction site signaling band in galvanized sheet
 Bande de signalisation de chantier en tôle galvanisée

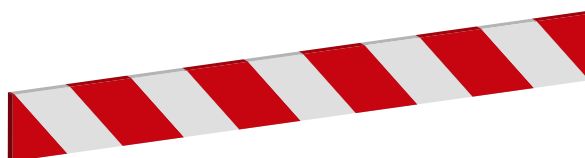

Code	L/cm	H/cm
RECMOB_TRBAND	200	26